

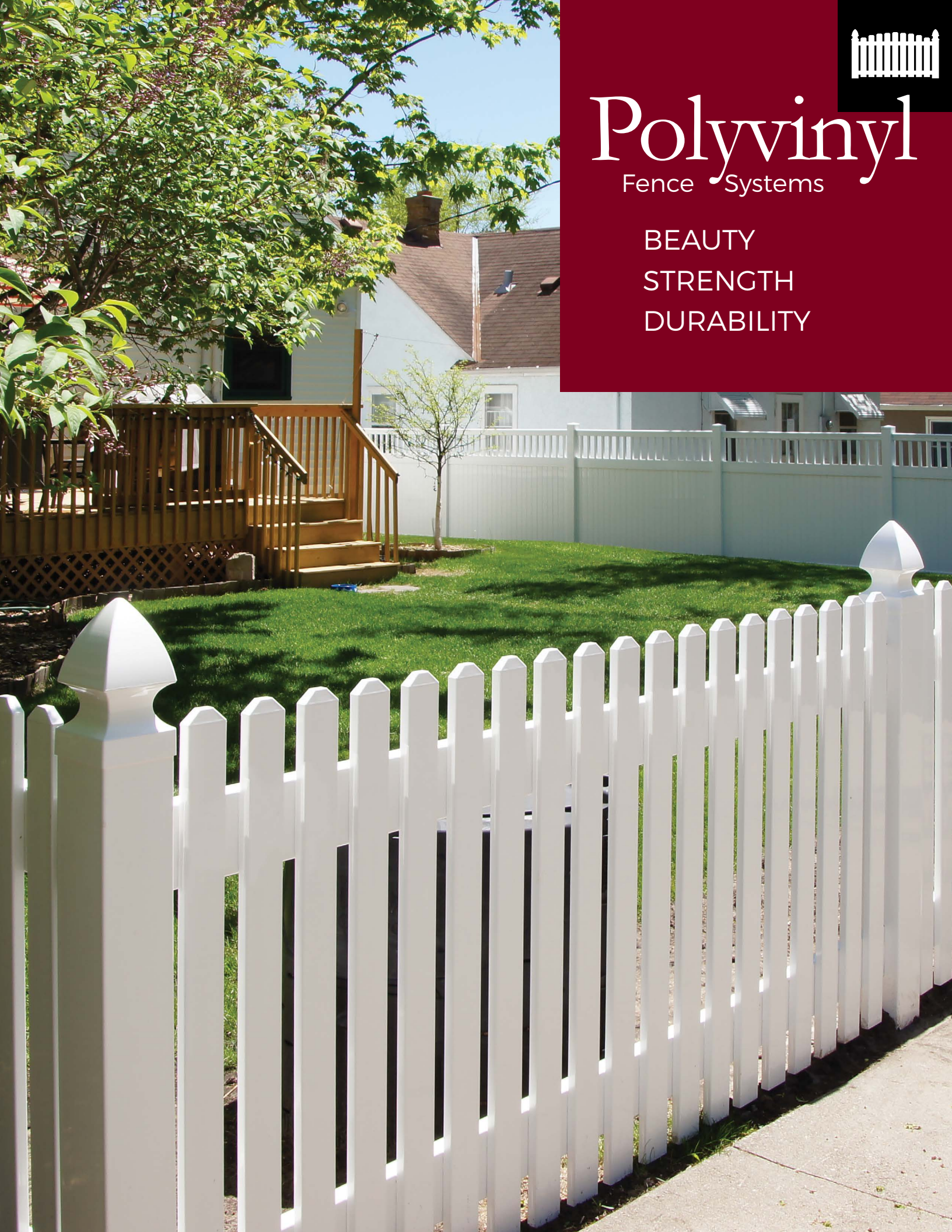

Polyvinyl

Fence Systems

BEAUTY
STRENGTH
DURABILITY





DYNAMIC SOLUTIONS INNOVATION

Since 1984 Digger Specialties, Inc. (DSI) has been manufacturing quality products for the fence and building products industry.

At DSI we are continually working to provide solutions through innovative product development and design to bring the best products to our customers, the marketplace and the home owner.

Polyvinyl Fence Systems offers privacy, semi-privacy, picket, ornamental, and post & rail designs.



Digger Specialties, Inc. is proud to offer one of the strongest warranties in the industry. Our Aluminum Lifetime Limited Warranty and our Vinyl Transferrable Lifetime Limited Warranty demonstrates our faith in our product and our commitment to you.

Visit diggerspecialites.com to view and register a DSI warranty.



Digger Specialties, Inc. is proud to be an American company manufacturing quality American made products at our plants in Indiana, North Carolina, Georgia, and Missouri.



COMMITTED TO THE ENVIRONMENT AND OUR COMMUNITY

DSI is proud to be an environmentally aware company that continues to update our practices to reduce our carbon footprint. DSI consistently recycles our cardboard, wood, steel banding, zinc die cast, and heat shrink scrap. DSI also utilizes both aluminum and vinyl extrusions that contain recycled content.

DSI is pleased to support our community by outsourcing a portion of our packaging functions to a local company that provides meaningful employment to individuals with disabilities.



TABLE OF CONTENTS

Features & Benefits	2
Colors	3
Privacy Fence	4 - 7
Designer Fence	8 - 9
Semi-Privacy Fence	10 - 11
Picket Fence	12 - 13
Ornamental Fence	14
Post & Rail Fence	15
Gates and Gate Hardware	16 - 20
Accessories	21

FEATURES & BENEFITS

Notched Rails and Snap Buttons

Our Notched Rails and Snap Button systems lock rails into place providing a sturdy, durable rail for your fence.

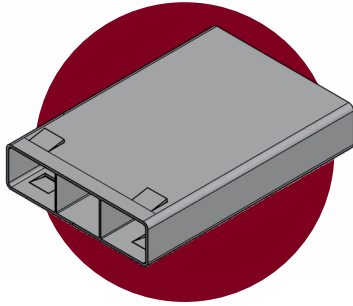

Low Maintenance

Polyvinyl Fence offers a low maintenance solution to your outdoor living area. Both our vinyl and aluminum are easy to clean and maintain and both come with a weathering warranty.



Matching Walk Gates

All our Polyvinyl Fence styles have matching aluminum reinforced walk gates to accent your fence. Gates are available in both single and double gate options.

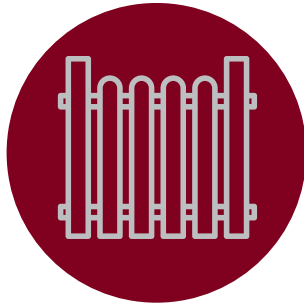

Lifetime Limited Warranty

DSI offers one of the best warranties in the industry. All Polyvinyl Fence products are covered by either our Aluminum Lifetime Limited Warranty or our Vinyl Transferrable Lifetime Limited Warranty offering you peace of mind in your investment.



Pool Code Approved



Polyvinyl Fence combines safety with style. Fence models marked with this symbol

comply with ASTM F2409 and 1908 pool codes for height and spacing. Always check with your local building code authority as local codes may differ.



VINYL COLORS

DSI Vinyl Products are available in six colors. Our Mocha, Antique Beige, Cottage Grey, and Sienna colors are available for **select** products. Please see individual product pages for availability.

Colors shown are a close representation of the true color. Please consult actual samples for accurate colors.

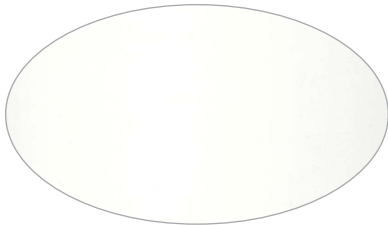

White

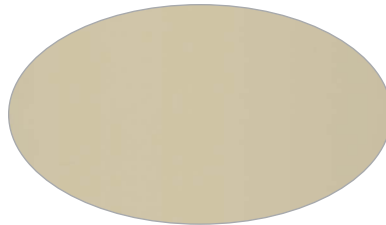

Tan

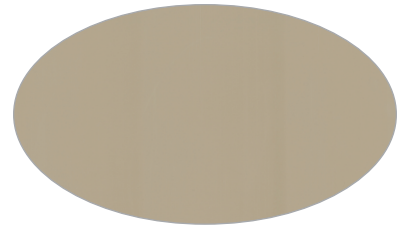

Mocha



Antique Beige



Cottage Grey



Sienna



PRIVACY

KINGSTON



White

Tan

Mocha



for 72", 84", and 96" heights

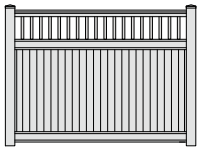

48", 60", 72", 84", 96"

MAJESTIC II

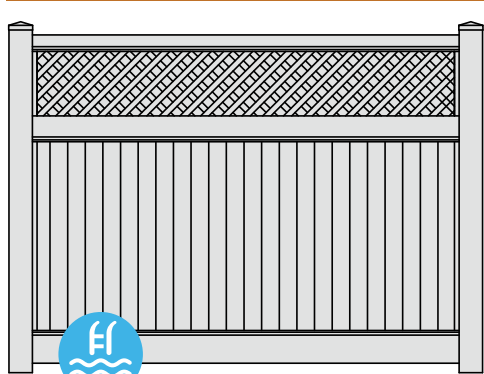

White

Tan

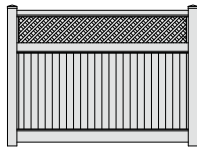

48", 60", 72"

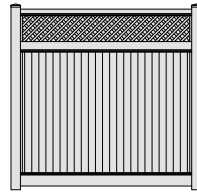

84", 96"

SUPERIOR



White

Tan

Mocha

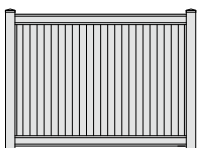

48", 60", 72"

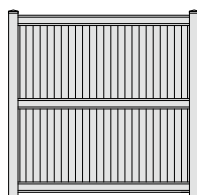

84", 96"

SUPERIOR II



White

Tan

Mocha

Antique Beige

Cottage Grey

Sienna

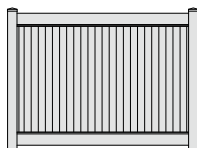

48", 60", 72"
with 11.28" Verticals

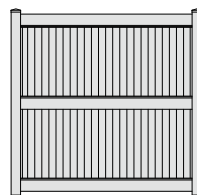

84", 96"
with 11.28" Verticals

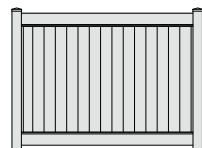

48", 60", 72"
with 6" Verticals

Rails and Posts available in White, Tan, Mocha, and Sienna only



Polyvinyl Privacy Fence offers privacy and security for your outdoor living space while offering styles and colors to enhance your yard. Whether you are protecting your family and pets or creating a secluded space for your pool our Privacy Fence will ensure your outdoor living space is safe and beautiful.

TRI-MAX II

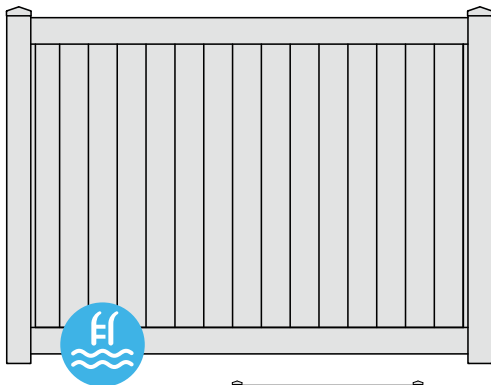

- White
- Tan
- Mocha

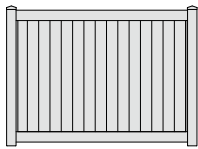

48", 60", 72"

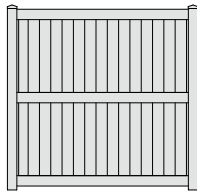

84", 96"

TRI-MAX II with Vertical Topper

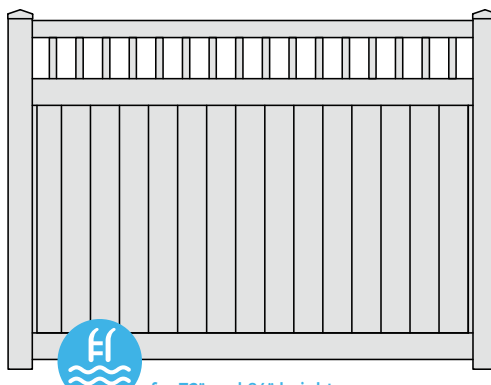

- White
- Tan
- Mocha



for 72" and 84" heights

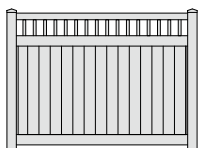

60", 72", 84"

TRI-MAX II with Lattice Topper

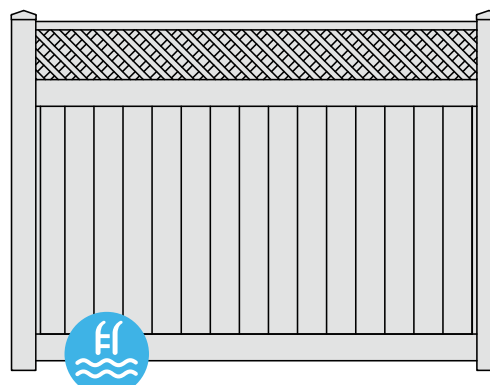

- White
- Tan

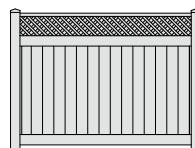

72"

PRIVACY STYLES





SPECIFICATIONS

Styles	Infill Colors	Heights	Racking	Section Width	Infill Size	Rails	Post Size	Standard Post Cap
Kingston	White Tan Mocha	48", 60", 72" 84", 96" w/Aluminum Reinforced Mid-Rail	2" Standard Optional 7° Rackable Section (12" per 8' Section)	8' Per Ft. Section Widths Available	7/8" x 11.28" Snap Lock Tongue & Groove 1-3/8" Square Vertical Accent w/3-1/2" Spacing	1-3/4" x 5-1/2" Aluminum Reinforced Bottom Rail	5" x 5"	Flat Cap
Majestic II	White Tan	48", 60", 72" 84", 96" w/Aluminum Reinforced Mid-Rail	2" Standard Optional 7° Rackable Section (12" per 8' Section)	8' Per Ft. Section Widths Available	7/8" x 11.28" Snap Lock Tongue & Groove 1-7/8" Diagonal Lattice	1-3/4" x 3-1/2" Top Deco Rail 1-3/4" x 5-1/2" Mid Deco Rail 2" x 7" Deco Bottom Rail with Aluminum Reinforcement	5" x 5"	Flat Cap
Superior	White Tan Mocha	48", 60", 72" 84", 96" w/Aluminum Reinforced Mid-Rail	2" Standard Optional 7° Rackable Section (12" per 8' Section)	8' Per Ft. Section Widths Available	7/8" x 11.28" Snap Lock Tongue & Groove	1-3/4" x 5-1/2" Aluminum Reinforced Bottom Rail	5" x 5"	Flat Cap
Superior II	White Tan Mocha	48", 60", 72" 84", 96" w/Aluminum Reinforced Mid-Rail	2" Standard Optional 7° Rackable Section (12" per 8' Section)	8' Per Ft. Section Widths Available	7/8" x 11.28" Snap Lock Tongue & Groove	2" x 7" Aluminum Reinforced Bottom Rail	5" x 5"	Flat Cap
	Antique Beige Cottage Grey Sienna	48", 60", 72"	10" Standard	8' Per Ft. Section Widths Available	7/8" x 6" Tongue & Groove	2" x 7" Aluminum Reinforced Bottom Rail	5" x 5"	Flat Cap
Tri-Max II	White Tan Mocha	48", 60", 72" 84", 96" w/Aluminum Reinforced Mid-Rail	10" Standard	8'	7/8" x 6" Snap Lock Tongue & Groove	1-1/2" x 5-1/2" Aluminum Reinforced Bottom Rail	5" x 5"	Flat Cap
Tri-Max II with Vertical Topper	White Tan Mocha	60", 72" 84" w/Aluminum Reinforced Mid-Rail	10" Standard	8'	7/8" x 6" Snap Lock Tongue & Groove 7/8" x 1-1/2" Vertical Accent w/4-1/8" Spacing	1-3/4" x 3-1/2" Top Rail 1-1/2" x 5-1/2" Mid and Bottom Rail. Bottom Rail includes Aluminum Reinforcement	5" x 5"	Flat Cap
Tri-Max II with Lattice Topper	White Tan	72"	10" Standard	8'	7/8" x 6" Snap Lock Tongue & Groove	1-1/2" x 5-1/2" Aluminum Reinforced Bottom Rail	5" x 5"	Flat Cap

*Aluminum Stiffeners Required in All Line & End Posts for 84" & 96" Heights.

FEATURES



Reinforced Bottom Rail Prevents Sagging on Superior and Kingston Models.



Reinforced Bottom Rail Prevents Sagging on Superior II, Majestic II, and all Tri-Max II Models.

DESIGNER

NARROW VERTICALS

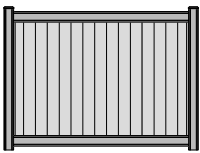

48", 60", 72"
with 6" Verticals

WIDE VERTICALS

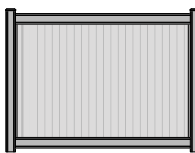

48", 60", 72"
with 11.28" Verticals

SPECIFICATIONS

Style	Infill Colors	Heights	Racking	Section Width	Infill Size	Rails	Post Size	Standard Post Cap
Designer	White Tan Mocha	48", 60", 72"	2" Standard Optional 7° Rackable Section (12" per 8' Section)	8' Per Ft. Section Widths Available	7/8" x 11.28" Snap Lock Tongue & Groove	1-1/4" x 5-1/2"	3" x 5"	Flat Cap
	Antique Beige Cottage Grey Sienna	48", 60", 72"	10" Standard	8' Per Ft. Section Widths Available	7/8" x 6" Tongue & Groove	1-1/4" x 5-1/2"	3" x 5"	Flat Cap



Designer Fence offers the privacy of a vinyl infill with the durability and aesthetics of a powder coated aluminum fence. The aluminum frame of Designer Fence is available in 12 standard AAMA 2604 colors and six vinyl infill colors. Designer Fence is a perfect way to protect your pool, hot tub, patio and yard.

ALUMINUM FRAME AND COMPONENT COLORS

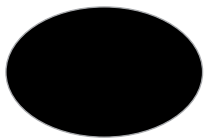

Satin Black



Black
Fine Texture



Ninety Bronze



Bronze
Fine Texture



Gloss Beige

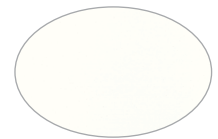

Gloss White



White Fine
Texture



Brown Fine
Texture



Speckled
Walnut



Sandy Shore



Chocolate

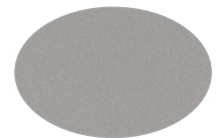

Silver

IN-FILL COLORS



White



Tan



Mocha



Antique Beige



Cottage Grey



Sienna

FEATURES



Line and End Post Cap



Corner Post Cap

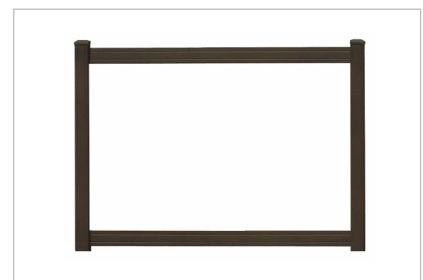

Posts and Rails can be ordered separately for use with your own in-fill

SEMI-PRIVACY

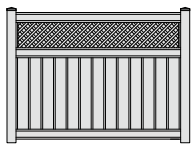

48", 60", 72"

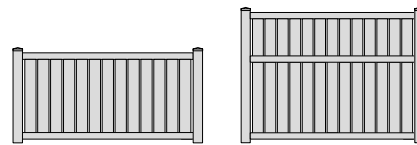

48"

60", 72"

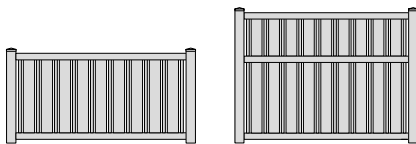

48"

60", 72"

FEATURES

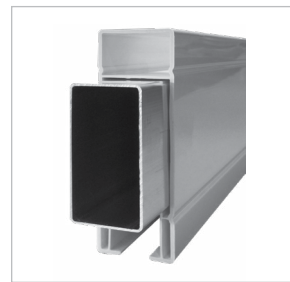

Dynasty Aluminum Reinforced Bottom Rail



Prestige and Princeton Aluminum Reinforced Bottom Rail



Our Semi-Privacy fence provides the same security as our privacy fence while allowing airflow through your fence. Our Semi-Privacy fence is available in three different styles to provide the perfect mix of style and seclusion for your outdoor space. Each of our Semi-Privacy fence styles are Pool Code approved.

SPECIFICATIONS

Style	Colors	Heights	Racking	Section Width	Vertical Size	Rails	Post Size	Standard Post Cap
Dynasty	White Tan	48", 60", 72"	3" Standard	8' Per Ft. Section Widths Available	7/8" x 6" Verticals w/15/16" Spacing 1-7/8" Diagonal Lattice	1-3/4" x 5-1/2" Aluminum Reinforced Bottom Rail	5" x 5"	Flat Cap
Prestige	White Tan Mocha	48", 60", 72"	3" Standard	8' Per Ft. Section Widths Available	7/8" x 6" Verticals w/7/8" Spacing	1-3/4" x 3-1/2" Aluminum Reinforced Bottom Rail	5" x 5"	Flat Cap
Princeton	White Tan Mocha	48", 60", 72"	4" Standard	8' Per Ft. Section Widths Available	7/8" x 6" & 7/8" x 1-1/2" Alternating Verticals w/1-1/16" Spacing	1-3/4" x 3-1/2" Aluminum Reinforced Bottom Rail	5" x 5"	Flat Cap



PICKET



GOOD NEIGHBOR

White

Tan

Mocha

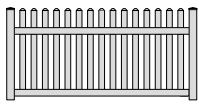

Straight
36", 42", 48"

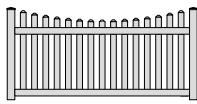

Concave
36", 42", 48"



REMINGTON

White

Tan

Mocha



for 72" height

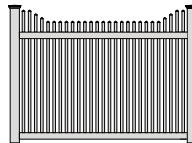

48", 60", 72"



STERLING

White

Tan

Mocha



for 48" height in Straight and Convex

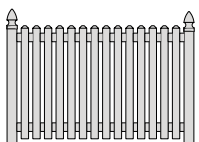

Straight
36", 42", 48"

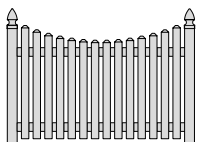

Concave
36", 42", 48"

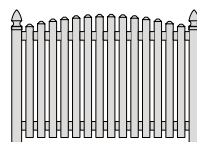

Convex
36", 42", 48"



SUPREME

White

Tan

Mocha



for 48", 60", and 72" heights in Straight and Convex and 60" & 72" heights in Concave

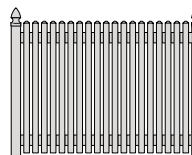

Straight
48", 60", 72"

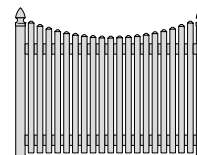

Concave
48", 60", 72"

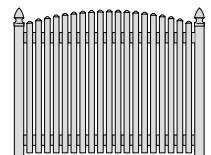

Convex
48", 60", 72"



There is nothing more Americana than a white Picket Fence. Polyvinyl Picket Fence provides a decorative boundary for your yard without blocking your view. Picket Fences are a stylish addition to both your front and back yards.

SPECIFICATIONS

Style	Colors	Heights	Racking	Section Width	Vertical Size	Rails	Post Size	Standard Post Cap
Good Neighbor	White Tan Mocha	36", 42", 48"	3" Standard	8'	7/8" x 3" Pickets w/3-11/16" Spacing	1-3/4" x 3-1/2" Aluminum Reinforced Bottom Rail	4" x 4"	Flat Cap
Remington	White Tan Mocha	48", 60", 72"	6" Standard	8' Per Ft/In Section Widths Available	1-3/8" x 1-3/8" Pickets w/1-15/16" Spacing	1-3/4" x 3-1/2" Aluminum Reinforced Bottom Rail	5" x 5"	Trim Cap
Sterling	White Tan Mocha	36", 42", 48"	24" Standard	6' Per Ft/In Section Widths Available	7/8" x 3" Pickets w/1-3/4" Spacing	1-3/4" x 3-1/2"	4" x 4"	Gothic Cap
Supreme	White Tan Mocha	48", 60", 72"	24" Standard	8' Per Ft/In Section Widths Available	7/8" x 3" Pickets w/1-11/16" Spacing	1-1/2" x 5-1/2"	5" x 5"	Gothic Cap

FEATURES

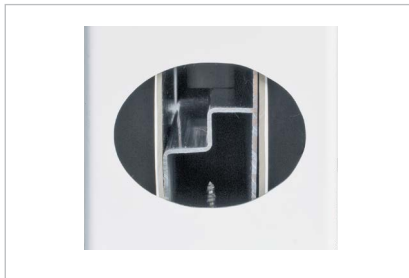

Good Neighbor Bottom Rail H-Channel Aluminum Reinforcement

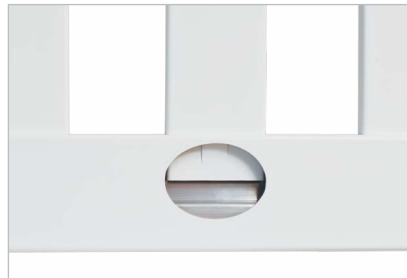

Good Neighbor Notched Pickets

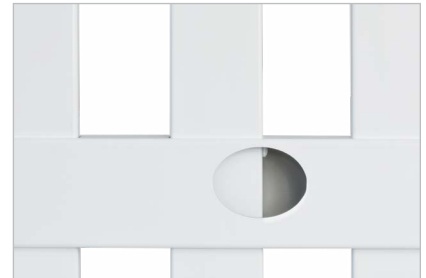

Good Neighbor Hidden Screw Top Rail Support Center Picket

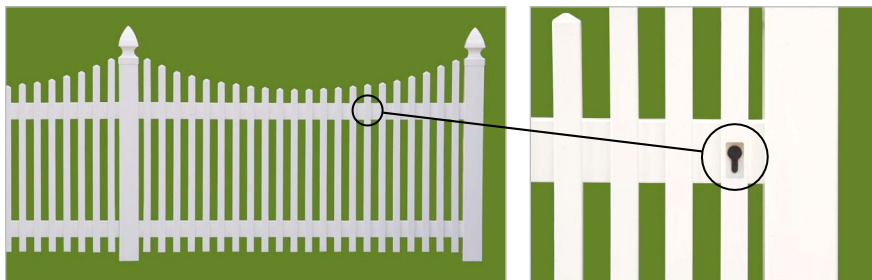

Patented Hidden Picket Attachment For Supreme and Sterling Picket Fencing (Internal View) No Unsightly Screws or Cap Plugs



Supreme and Sterling Dog Ear Picket Cap

ORNAMENTAL

The timeless beauty of our ornamental vinyl fence designs adds a touch of elegance to your yard. Both Colonial and Good Neighbor styles add security to both your front and back yard while offering a stylish addition to your home.

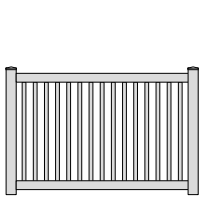

36", 42", 48", 50-1/2"

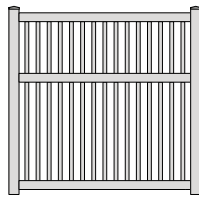

60", 72"

NOTE: Bottom Rail Aluminum Reinforced for 50 1/2", 60", and 72" Colonial Heights

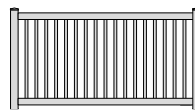

36", 42", 50-1/2"

SPECIFICATIONS

Style	Colors	Heights	Racking	Section Width	Vertical Size	Rails	Post Size	Standard Post Cap
Colonial	White Tan Mocha	36", 42", 48", 50-1/2"	6" Standard	6' Per Ft. Section Widths Available	7/8" x 1-1/2" Verticals w/2-15/16" Spacing	1-3/4" x 3-1/2" 50-1/2" Includes Aluminum Reinforced Bottom Rail	4" x 4"	Flat Cap
	White Tan Mocha	60", 72"	3" Standard	6' Per Ft. Section Widths Available	7/8" x 1-1/2" Verticals w/2-15/16" Spacing	1-3/4" x 3-1/2" Aluminum Reinforced Bottom Rail	4" x 4"	Flat Cap
Good Neighbor Yard	White Tan Mocha	36", 42", 50-1/2"	6" Standard	8'	7/8" x 1-1/2" Verticals w/3-11/16" Spacing	1-3/4" x 3-1/2" Aluminum Reinforced Bottom Rail	4" x 4"	Flat Cap



POST & RAIL

Post and Rail fence offers simplicity and open design for your landscape. Polyvinyl Post and Rail fence includes 2, 3, and 4 rail styles as well as the Crossbuck style.

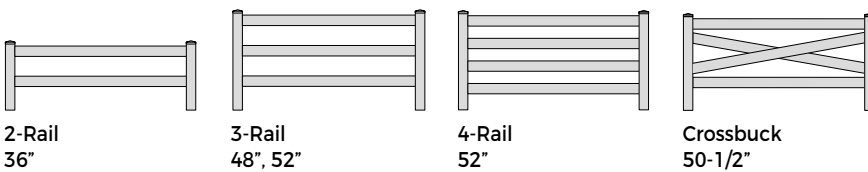

SPECIFICATIONS

Style	Colors	Heights	Section Width	Rails	Rail Spacing	Post Length	Post Size	Standard Post Cap
2-Rail	White, Tan, Mocha	36"	8'	1-1/2" x 5-1/2"	10-1/2"	5', 5-1/2'	5" x 5"	Flat Cap
3-Rail	White, Tan, Mocha	48", 52"	8'	1-1/2" x 5-1/2"	10-1/2"	6-1/2', 7', 7-1/2'	5" x 5"	Flat Cap
	White, Tan	52"	8'	2" x 6"	10-1/2"	7', 7-1/2"	5" x 5"	Flat Cap
4-Rail	White, Tan, Mocha	52"	8'	1-1/2" x 5-1/2"	6-1/2"	7', 7-1/2'	5" x 5"	Flat Cap
	White, Tan	52"	8'	2" x 6"	6-1/2"	7', 7-1/2'	5" x 5"	Flat Cap
Crossbuck	White, Tan, Mocha	50-1/2"	8'	1-1/2" x 5-1/2"		7'	5" x 5"	Flat Cap

STANDARD GATES

WALK GATES

Gate Style	Single Gate Opening Widths					Double Gate Opening Widths				
	36"	42"	48"	60"	72"	72"	84"	96"	120"	144"
Privacy	Designer	✓	✓	✓	✓	✓	✓	✓	✓	✓
	Kingston	✓	✓	✓	✓	✓	✓	✓	✓	✓
	Majestic II	✓	✓	✓	✓	✓	✓	✓	✓	✓
	Superior	✓	✓	✓	✓	✓	✓	✓	✓	✓
	Superior II	✓	✓	✓	✓	✓	✓	✓	✓	✓
	Tri-Max II	✓	✓	✓	✓		✓	✓	✓	✓
	Tri-Max II w/Vertical Topper	✓	✓	✓	✓		✓	✓	✓	✓
	Tri-Max II w/Lattice Topper	✓	✓	✓	✓		✓	✓	✓	✓
Semi-Privacy	Dynasty	✓	✓	✓	✓	✓	✓	✓	✓	✓
	Prestige	✓	✓	✓	✓	✓	✓	✓	✓	✓
	Princeton	✓	✓	✓	✓	✓	✓	✓	✓	✓
Picket	Good Neighbor			✓	✓	✓		✓	✓	✓
	Remington	✓	✓	✓	✓	✓	✓	✓	✓	✓
	Sterling	✓	✓	✓	✓	✓	✓	✓	✓	✓
	Supreme	✓	✓	✓	✓	✓	✓	✓	✓	✓
Ornamental	Colonial	✓	✓	✓	✓	✓	✓	✓	✓	✓
	Good Neighbor Yard	✓	✓	✓	✓	✓	✓	✓	✓	✓

FEATURES



Aluminum Reinforced Frame

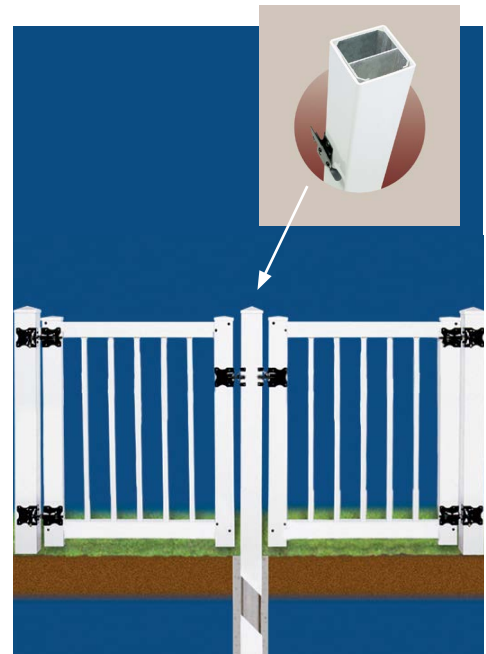

Removable Center Post is Recommended on Double Gates.



Each of our Polyvinyl fence styles have optional matching walk gates. All walk gates include an aluminum reinforced frame. Walk gates come in both single and double width styles allowing for a variety of options.

POST & RAIL GATES

Single Gate Opening Widths

Gate Style	48"		72"		96"		120"		144"		192"	
	Vinyl	Aluminum	Vinyl	Aluminum	Vinyl	Aluminum	Vinyl	Aluminum	Vinyl	Aluminum	Vinyl	Aluminum
2-Rail	✓	✓	✓	✓	✓	✓	✓	✓		✓		✓
3-Rail	✓	✓	✓	✓	✓	✓	✓	✓		✓		✓
4-Rail	✓	✓	✓	✓	✓	✓	✓	✓		✓		✓
Crossbuck	Gates not available in Crossbuck style. See 4-Rail.											

Double Gate Opening Widths

Gate Style	96"		144"		192"		240"		288"		384"	
	Vinyl	Aluminum	Vinyl	Aluminum	Vinyl	Aluminum	Vinyl	Aluminum	Vinyl	Aluminum	Vinyl	Aluminum
2-Rail	✓	✓	✓	✓	✓	✓	✓	✓		✓		✓
3-Rail	✓	✓	✓	✓	✓	✓	✓	✓		✓		✓
4-Rail	✓	✓	✓	✓	✓	✓	✓	✓		✓		✓
Crossbuck	Gates not available in Crossbuck style. See 4-Rail.											

FEATURES

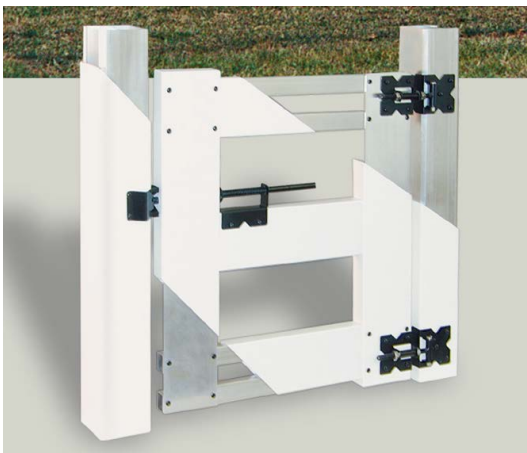

Aluminum Reinforced Frame

ALUMINUM FRAME GATES





DSI offers both Welded Aluminum Frame Gates and Adjustable Aluminum Frame Gates. These gates have a Powder Coated Aluminum Frame and vinyl in-fills designed for strength and durability.

ADJUSTABLE ALUMINUM FRAME GATES



Gate Style	Single Gate Opening Widths			Double Gate Opening Widths		
	72"	96"	120"	144"	192"	240"
Designer Fence	✓	✓	✓	✓	✓	✓
Superior	✓	✓	✓	✓	✓	✓
Superior II	✓	✓	✓	✓	✓	✓
Tri-Max II	✓	✓	✓	✓	✓	✓

- Powder Coated Aluminum Frame
- Vinyl In-Fill
- Aluminum 6" Posts (.185" Wall): Gate Posts
- Gates available in 72", 84", & 96" heights

WELDED ALUMINUM FRAME GATES



Gate Style	Single Gate Opening Widths				Double Gate Opening Widths			
	72"	84"	96"	120"	144"	168"	192"	240"
Majestic II	✓		✓	✓	✓		✓	✓
Superior	✓	✓	✓	✓	✓	✓	✓	✓
Tri-Max II w/Vertical Topper	✓		✓	✓	✓		✓	✓

- Powder Coated Aluminum Frame
- Vinyl In-Fill
- Aluminum 6" Posts (.185" Wall): Gate Posts
- Gates available in 72", 84" & 96" heights
- Gate openings of 60" and 120" are available for some models and heights.

GATE HARDWARE

HINGES

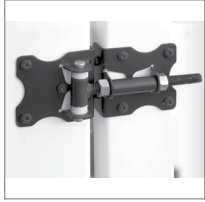

Residential Hinge



Tru-Close Hinge



Commercial Hinge for Post & Rail or Aluminum Frame Gates

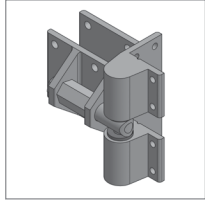

HD Adjustable Hinge for 1-1/2" Gate Side

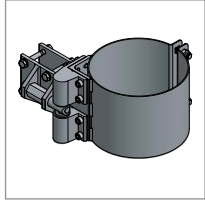

Adjustable Bollard Hinge for 6-5/8" Round Posts



Mocha and Tan are available for **select** products. Please contact customer service for availability.

LATCHES

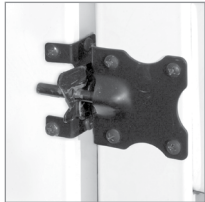

Residential Latch



Magna Latch Vertical Pull 6"



Magna Latch Vertical Pull 20-1/4"



Lokk Latch



Lokk Latch Deluxe

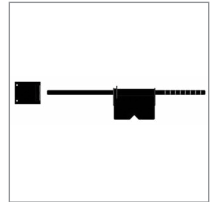

Commercial Latch for Post & Rail

CANEBOLT

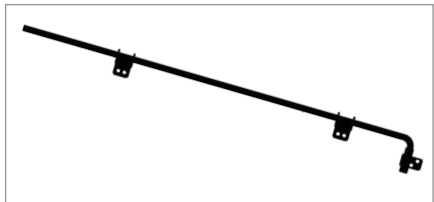

Canebolt (Drop Pin Kit)

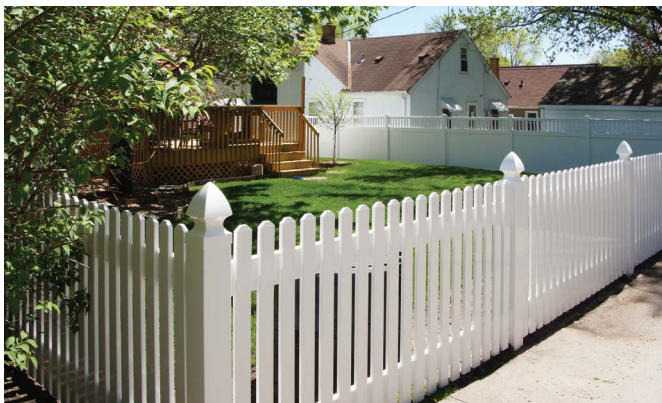



VINYL POST CAPS



External Flat Cap



Gothic Cap



Ball Cap



Trim Cap



Internal Flat Cap
(For Post & Rail)



Mocha and Sienna are available for **select** products. Please see individual product pages for availability.

MAGENA STAR POST CAPS

Magenta Star Ornamental Low Voltage and Solar Lights.
Visit magenastar.com for more information and to see additional styles.



Ornamental
Low Voltage 4"

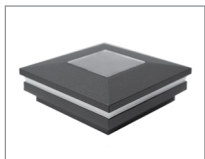

Ornamental
Solar 4"

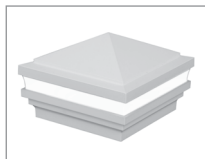

Ornamental
Low Voltage 5"

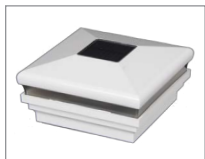

Ornamental
Solar 5"



Mocha is available for **select** products. Please see individual product pages for availability.

TOOLS



Template Kit



Notching Tool

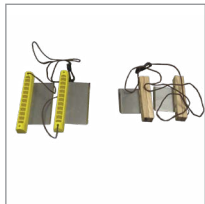

Rail Removers



DSI FAMILY OF PRODUCTS



**Digger
Specialties
Inc.**

diggerspecialties.com

Stay Connected



We have tried to make this catalog comprehensive and factual. We reserve the right to discontinue at any time, without notice, colors, materials, equipment and availability. Since some information may have been updated since the time of printing, we are not responsible for typographical or pictorial errors. Materials shown may vary slightly from actual colors. ©Digger Specialties 2020/01 99508